

mimSAFE

www.mimsafe.se

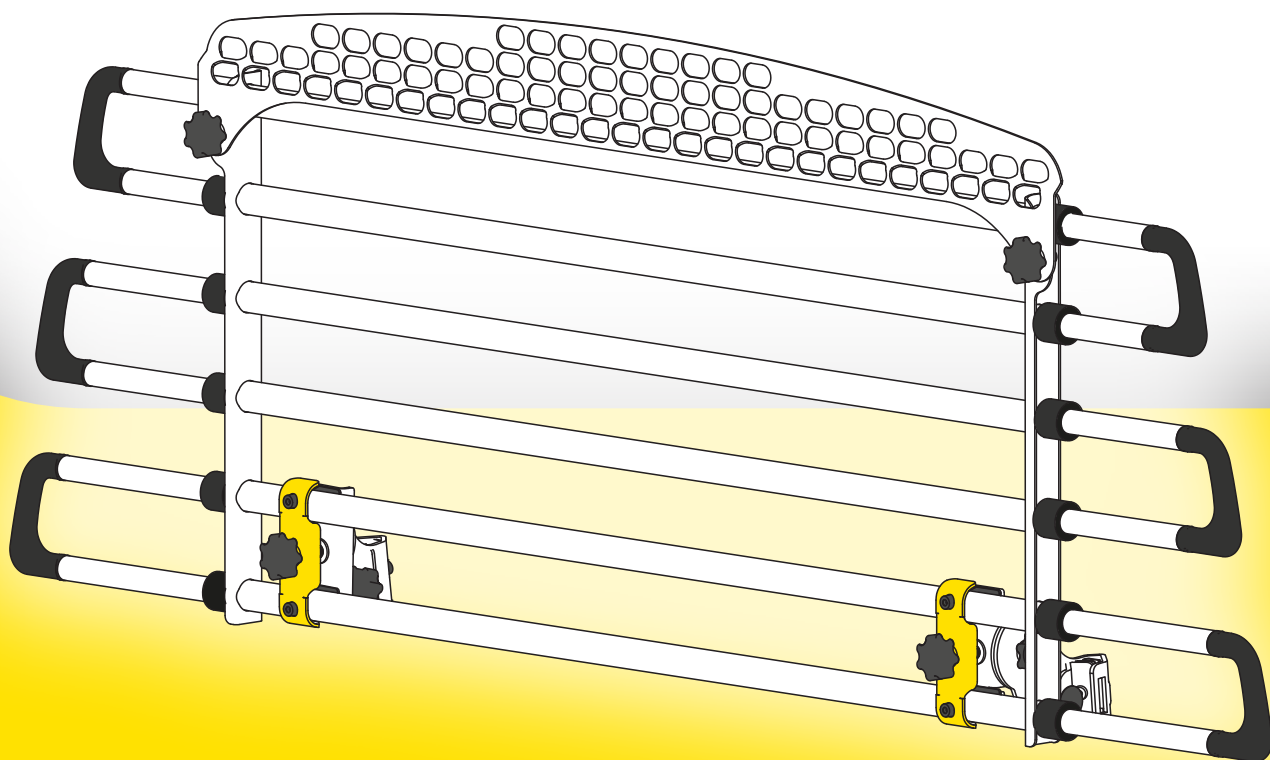

ASSEMBLY INSTRUCTIONS

VARIOBARRIER

headrest medium

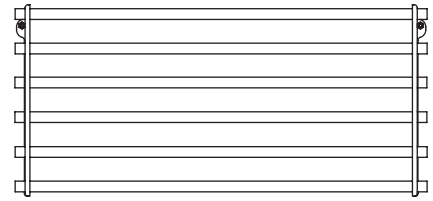
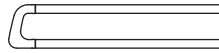
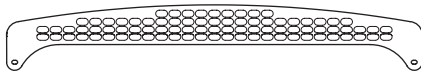
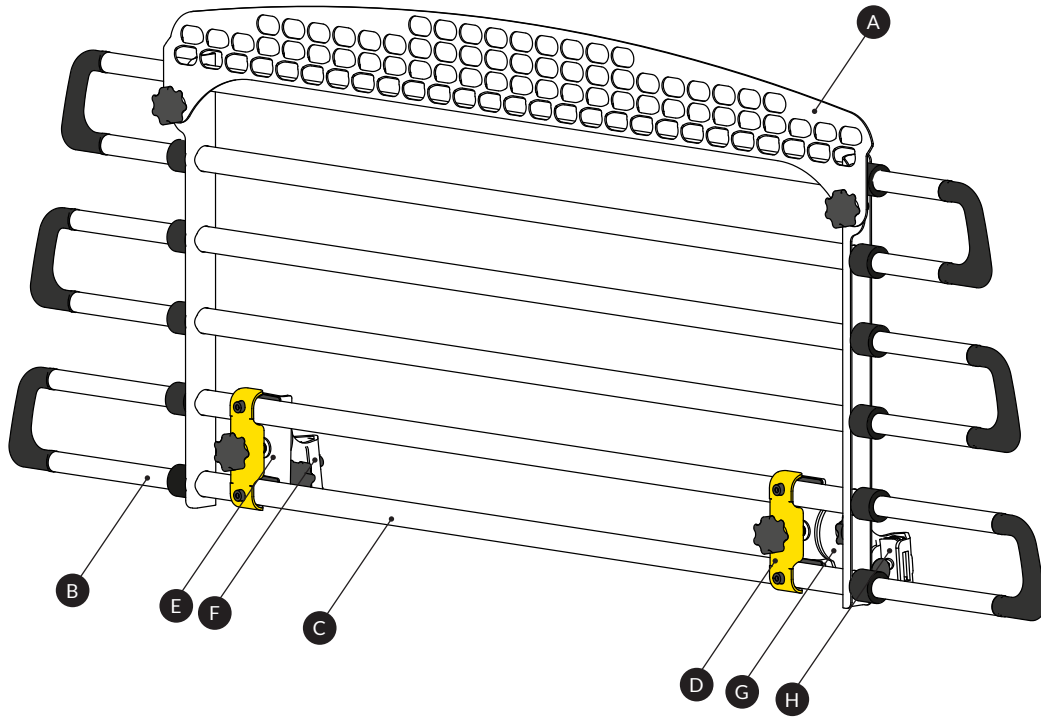

A	F308A	1X
	Part no	No of items

B	F521	6X
	Part no	No of items

C	FS544	1X
	Part no	No of items

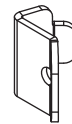
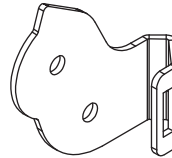
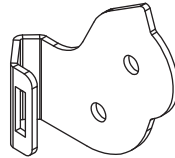
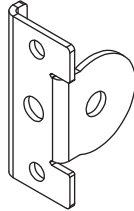
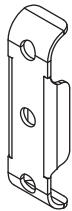









D	F310A	2X
	Part no	No of items

E	F310B	2X
	Part no	No of items

F	F310CL	1X
	Part no	No of items

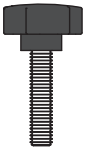
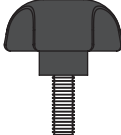
G	F310CR	1X
	Part no	No of items

H	F310D	2X
	Part no	No of items

<p>M-R3015M8S 2X</p> 	<p>M-460641BF 2X</p>  <p>rubber</p>	<p>M-460641D 12X</p>  <p>rubber</p>	<p>M-460641AY 12X</p>  <p>rubber end caps</p>	<p>M-460641AL 12X</p>  <p>plastic end caps</p>
<p>M-R3015M835S 2X</p> 	<p>M-SR4025M820S 2X</p> 	<p>M-R3015M610S 2X</p> 	<p>M-VBM8x30S 2X</p> 	<p>M-VBM8x25S 2X</p> 

STEP
1

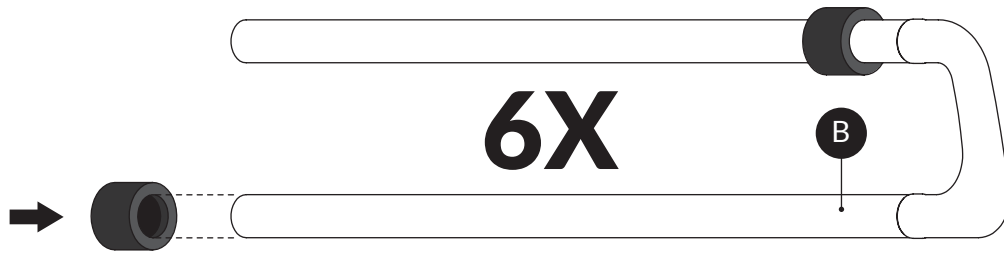

M-460641AY
12X

rubber end caps

STEP
2

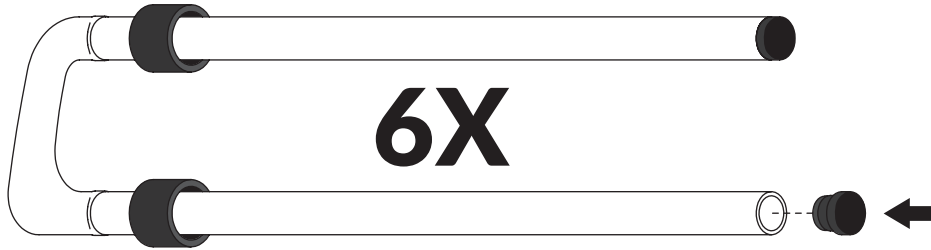

M-460641AL
12X

plastic end caps

STEP
3

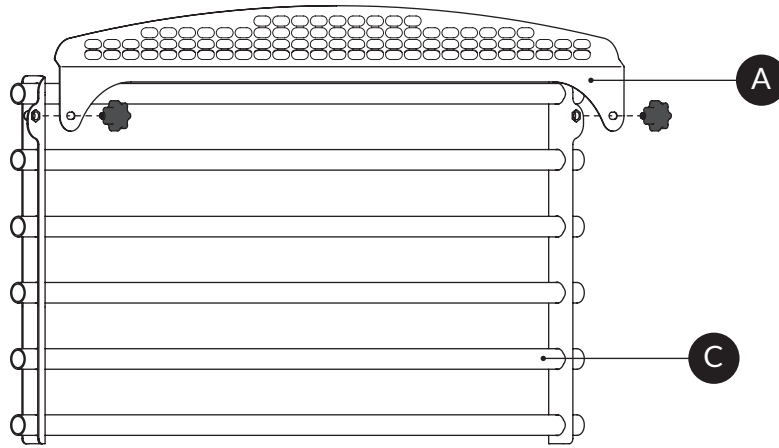

M-R3015M610S
2X

STEP
4

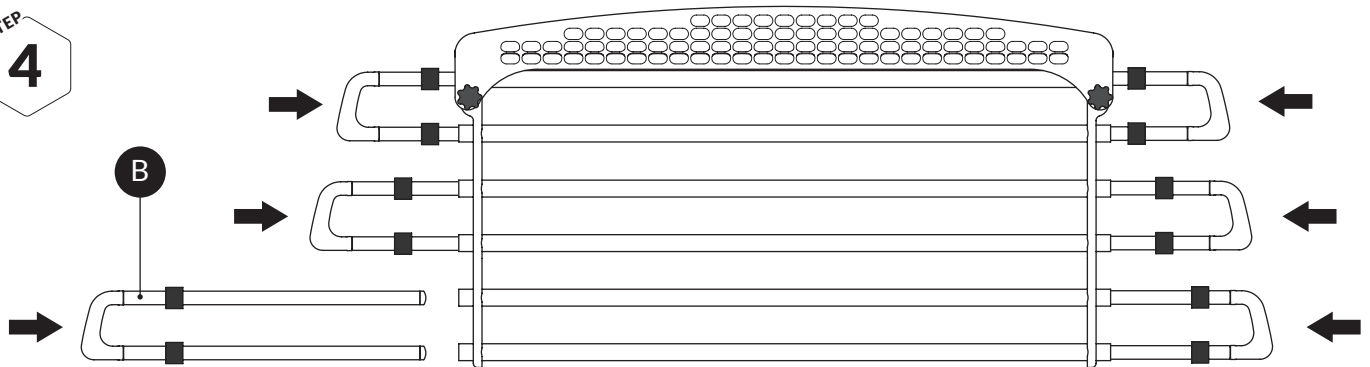

STEP
5

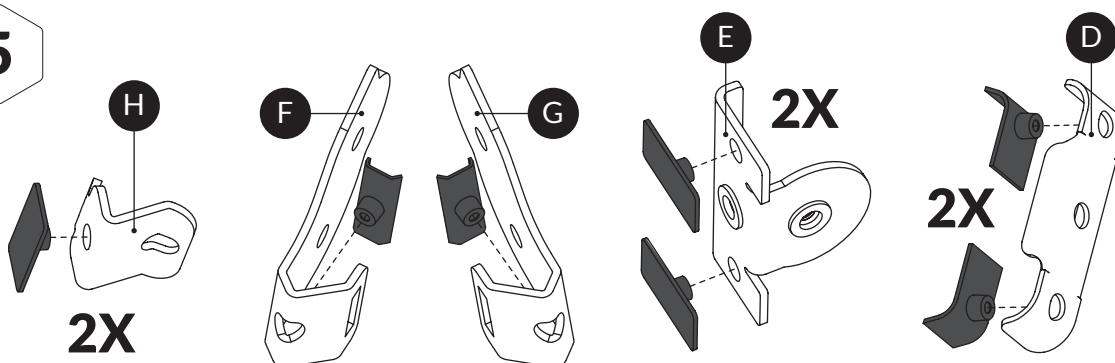

M-460641D
12X

rubber

STEP
6

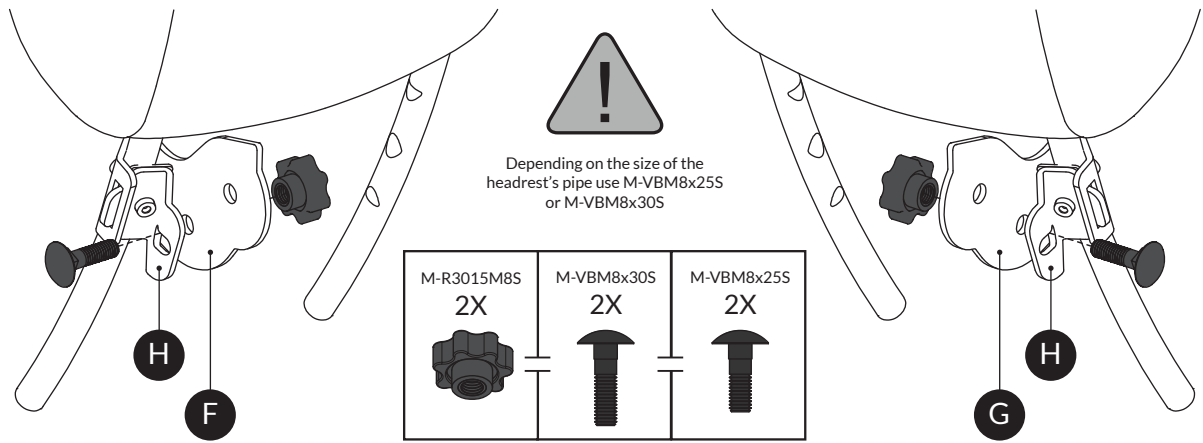

STEP
7

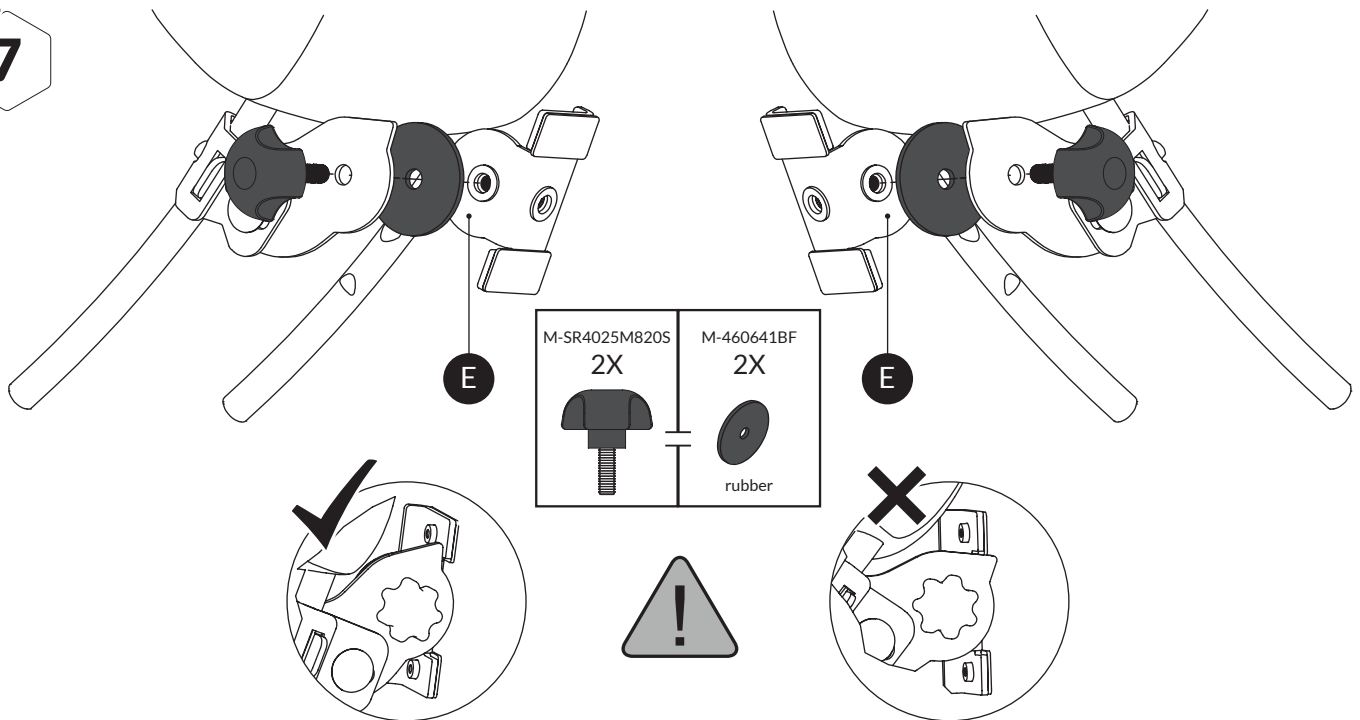

STEP
8

